

REVISION HISTORY			
Rev	DESCRIPTION	DATE	APPROVED
△1	Changed Detail Q ;	Apr 19 2017	Z.zhang

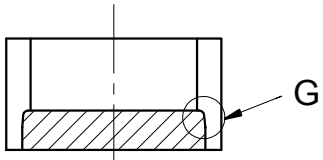

Section E-E

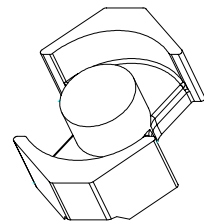
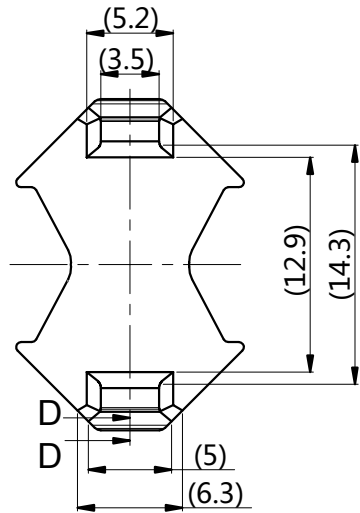
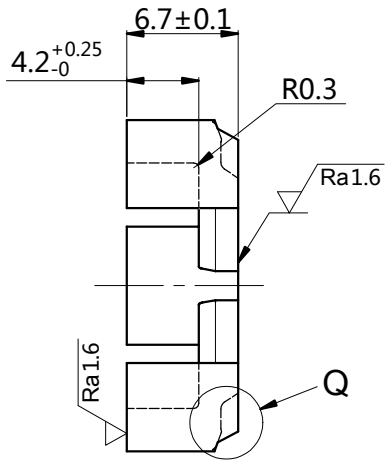
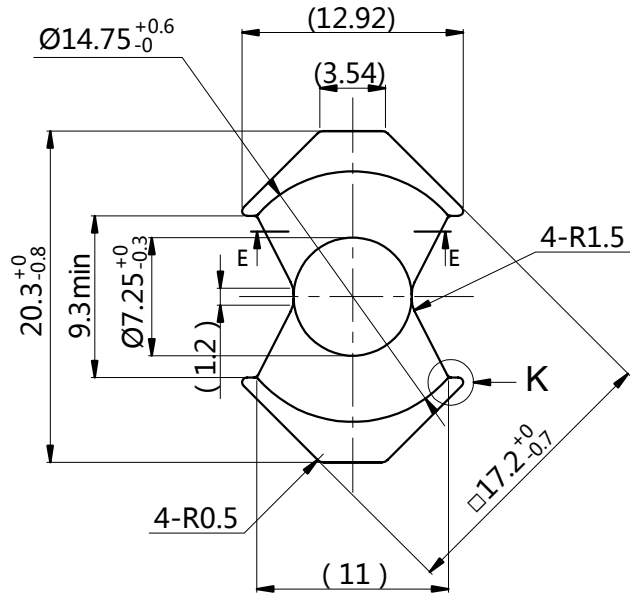
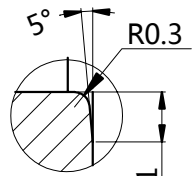

Detail G

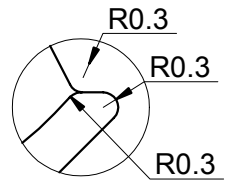

Detail K

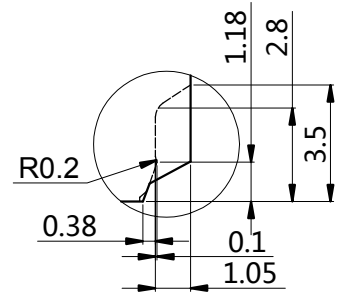

△1 Detail Q

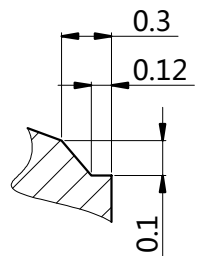

Section D-D

	Scale	2.5 : 1	Material	Customer Part number	
	Unit:	Standard tolerances		Product Name	
mm	±0.1	RM-7S			
Approved by	Created by	Document type	Rev	Drawing No.	
Y.Higuchi	Z.zhang	Production drawing	01	PY161117M01	
Hitachi Metals (Hong kong) Ltd. Panyu Factory			Date of issue	Sheet	
			Apr 19 2017	1/1	